

## БАШЕННЫЙ КРАН С ПОДЪЕМНОЙ СТРЕЛОЙ

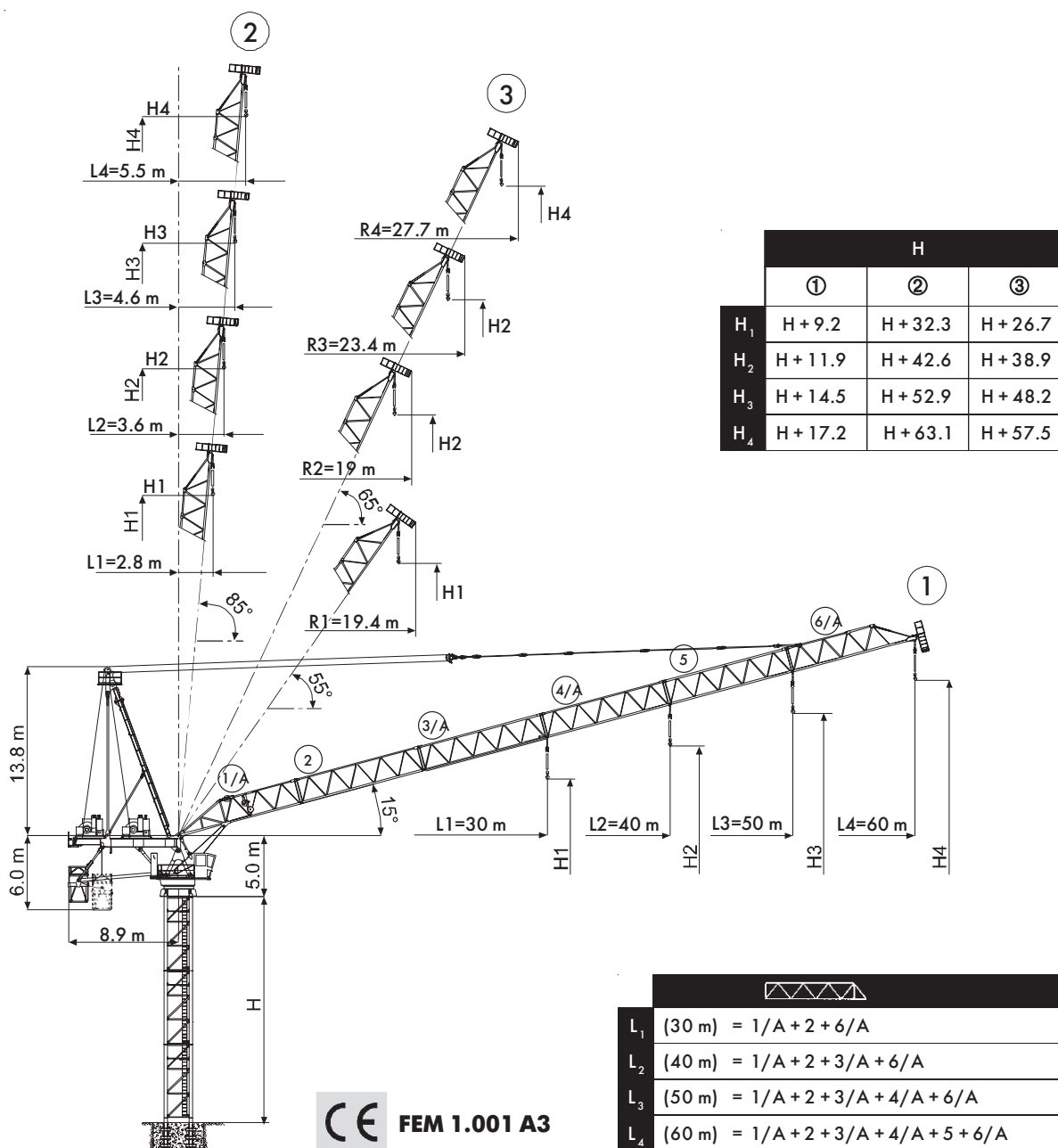

# CTL 630 -32 HD23

**Картограмма нагрузки**

**CTL 630-32**

			20	22	25	27	30	35	40	45	50	55	60
16 т	-	35 м	16.00	16.00	16.00	16.00	16.00	16.00	13.90	12.27	10.96	9.89	9.00
16 т	-	41.9 м	16.00	16.00	16.00	16.00	16.00	16.00	16.00	14.82	13.20		
32 т	-	21.8 м	32.00	31.78	27.80	25.64	22.93	19.46	16.85	14.82	13.20		
16 т	-	40 м	16.00	16.00	16.00	16.00	16.00	16.00	16.00				
32 т	-	22.6 м	32.00	32.00	28.84	26.60	23.80	20.20	17.50				
16 т	-	30 м	16.00	16.00	16.00	16.00	16.00						
32 т	-	22.8 м	32.00	32.00	29.08	26.82	24.00						

**Другие конфигурации**

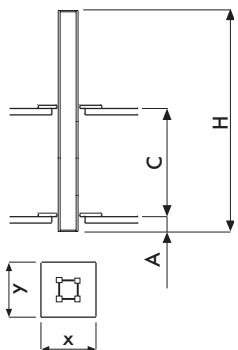

**i**  
Телескопический кран

HD 23 26/A	
[m]	
A <sub>min</sub>	<b>i</b>
C <sub>min</sub>	
H <sub>max</sub>	
x	
y	

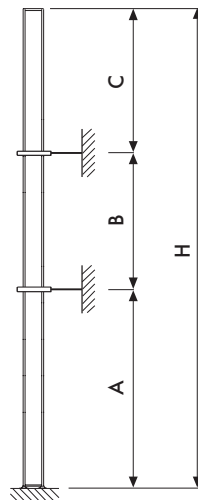

**i**  
Кран, прикрепленный к объекту

		HD23 R1		HD23 R2	
		[m]		[m]	
		L <sub>3-4</sub>	L <sub>1-2</sub>	L <sub>3-4</sub>	L <sub>1-2</sub>
A <sub>min/max</sub>		30/30		30/54	30/60
B <sub>min/max</sub>		24/30		24-30	24/36
C <sub>max</sub>		24-(30 <i>i</i> )	30-(36 <i>i</i> )	24-(30 <i>i</i> )	30-(36 <i>i</i> )
H <sub>max</sub>		<b>i</b>			

**Башня**

**HD23**

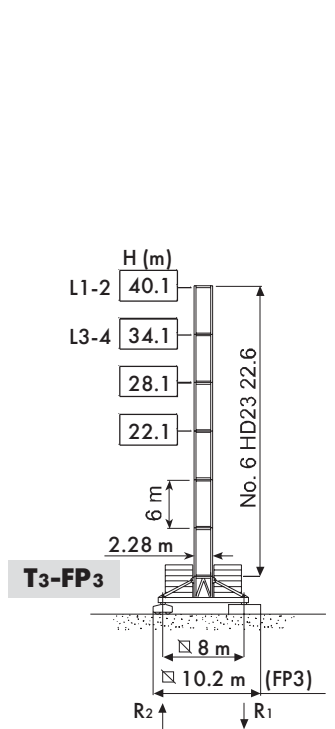

R1	1600 kN ●	1300 kN ◆
R2		
	140 t	

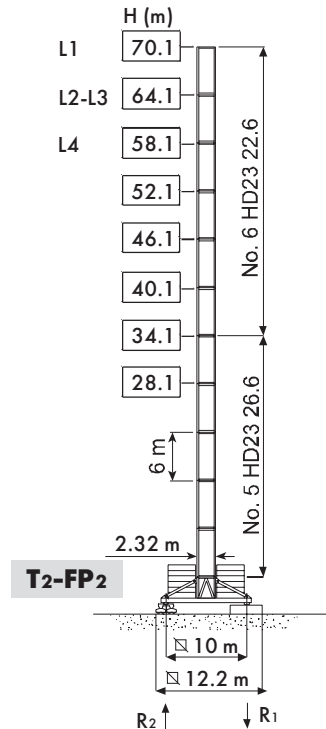

R1	1900 kN ●	1800 kN ◆
R2		
	180 t	

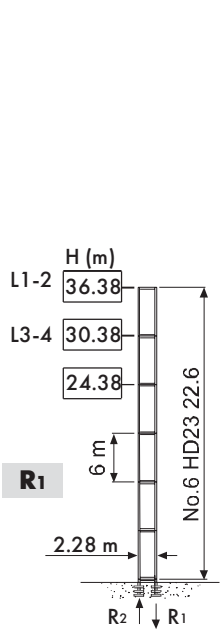

R1	3600 kN ●	3200 kN ◆
R2	2560 kN ●	2350 kN ◆
	116 t	

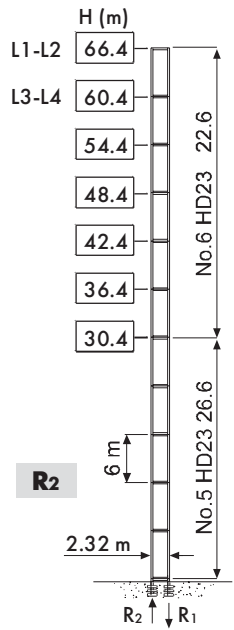



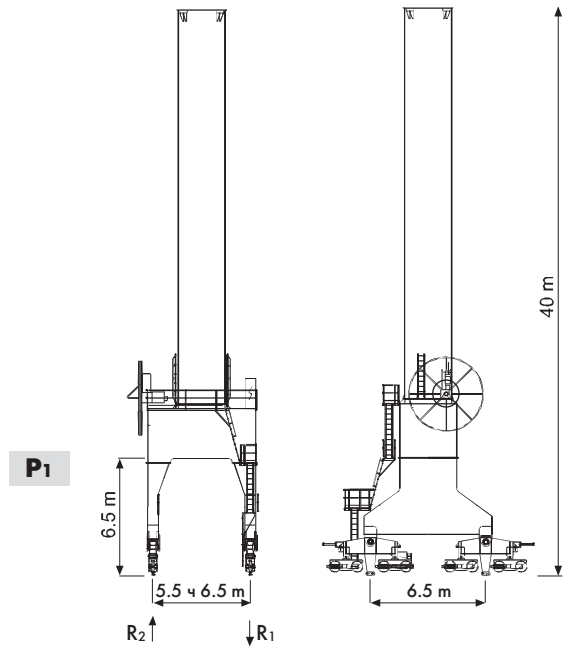

R1	4550 kN ●	5580 kN ◆
R2	3350 kN ●	4600 kN ◆
	148 t	















R1	●	●
R2	●	●
	250 t	

**Механизмы**









				
	SRWB 102 160/5	301 кВА*	400 В – 50 Гц	2000/14/CE
	SRWB 122 160/5	325 кВА*	460 В – 60 Гц	
	110 AWL 160	297 кВА*	400 В – 50 Гц / 460 В – 60 Гц	

\* Кран без оборудования для перевозки

		м/мин	т	кВт		
	<b>SRWB 102 160/5</b> 50 Hz		0 ⇌ 32	16	102	600 m
			0 ⇌ 50	10		
			0 ⇌ 80	6		
			0 ⇌ 125	3.5		
		0 ⇌ 16	32			
		0 ⇌ 25	20			
		0 ⇌ 40	12			
		0 ⇌ 63	7			
<b>SRWB 122 160/5</b> 60 Hz		0 ⇌ 38	16	112	600 m	
		0 ⇌ 60	10			
		0 ⇌ 96	6			
		0 ⇌ 150	3.5			
		0 ⇌ 19	32			
		0 ⇌ 30	20			
		0 ⇌ 48	12			
		0 ⇌ 76	7			
<b>110 AWL 160 LLC</b> D1		0 ⇌ 26	16	110	340 m	
		0 ⇌ 36	11.3			
		0 ⇌ 50	8.1			
		0 ⇌ 69	5.6			
		0 ⇌ 80	0.8			
		0 ⇌ 13	32			
		0 ⇌ 18	22.6			
		0 ⇌ 25	16.2			
		0 ⇌ 35	11.2			
		0 ⇌ 40	1.6			

	<b>LWL 11000</b>	2.8 мин	110 кВт
	<b>SCC 2 2 132 L</b>	0 ⇌ 0.65 об/мин	2 x 14 кВт
	<b>TVF 2RT 4M11</b>	0 ⇌ 24 м/мин	4 x 11 кВт
	<b>TSR 2 RG 4 M 8</b>	12 ⇌ 24 об/мин	4 x 80 Нм
	<b>TVF 4RT 8M11</b>	0 ⇌ 24 м/мин	8 x 11 кВт
			

	●	▲	■
	Максимальная Н [м]		
T <sub>3</sub>	28.1	40.1	40.1
T <sub>2</sub>	40.1	70.1	70.1
P <sub>1</sub>	-	40	40

-  Подъем
-  Перемещение
-  Поворот
-  Передвижение
-  Указания по уровню шума
-  Проконсультируйтесь с нами
-  Потребляемая мощность
-  Источник питания

Gru Comedil s.r.l.

A Terex Company



Divisione Automontanti

Via S. Egidio 42/A, 33074 Fontanafredda (PN) - Italy  
Tel. (+39) 0434 567 311 - Telefax (+39) 0434 998631

Via Alessandrina, 25 - 20095 Cusano Milanino (MI) - Italy  
Tel. (+39) 02 613 16011 - Telefax (+39) 02 613 16034

Internet e-mail: info@comedil.com  
Internet home page: www.comedil.com

Internet e-mail: info.CBR@comedil.com