

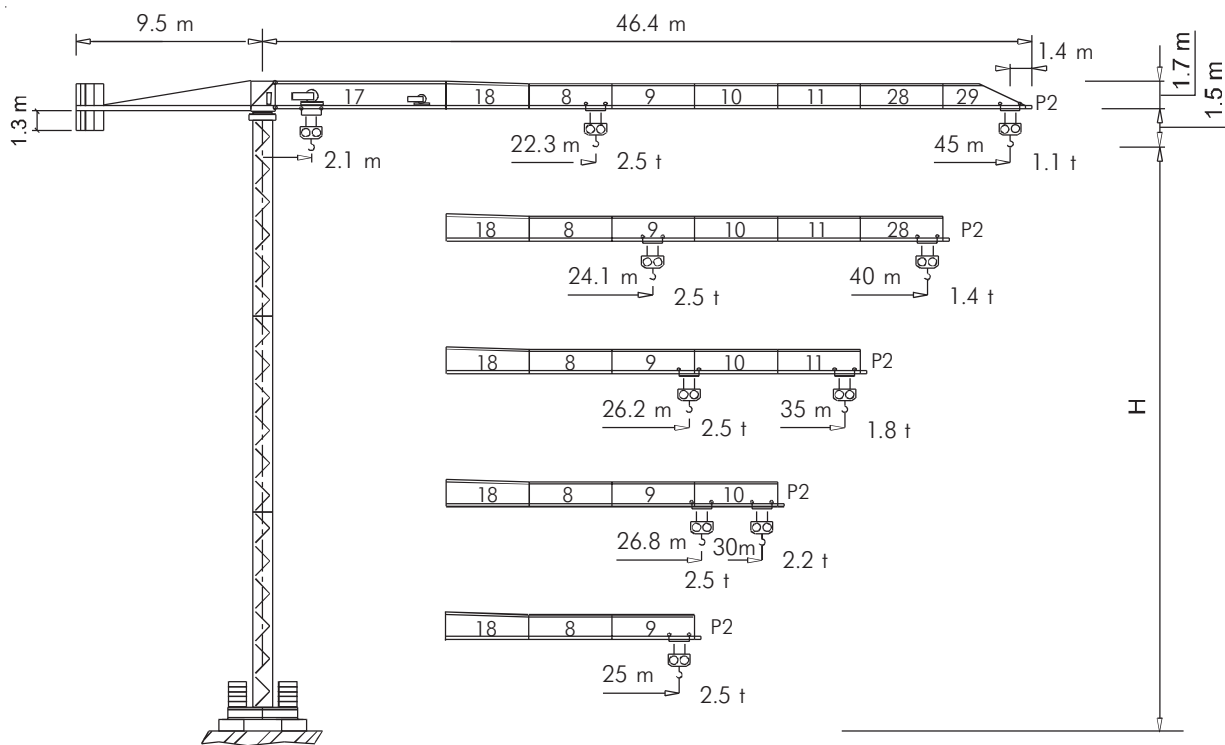

TEREX | COMEDIL



БАШЕННЫЙ КРАН «FLAT TOP»



CE FEM 1.001 A3

“CITY” СТТ 61 / А-2.5 ТS12

Картограмма нагрузки

		СТТ 61 / А -2.5										
		М	5	10	15	20	25	30	35	40	45	
2.5т	- 22.26 м	т	2.5	2.5	2.5	2.5	2.19	1.78	1.49	1.27	1.1	
2.5т	- 24.14 м	т	2.5	2.5	2.5	2.5	2.4	1.96	1.64	1.4		
2.5т	- 26.19 м	т	2.5	2.5	2.5	2.5	2.5	2.15	1.8			
2.5т	- 26.77 м	т	2.5	2.5	2.5	2.5	2.5	2.2				
2.5т	25 м	т	2.5	2.5	2.5	2.5	2.5					

Другие конфигурации





Башня

TS12

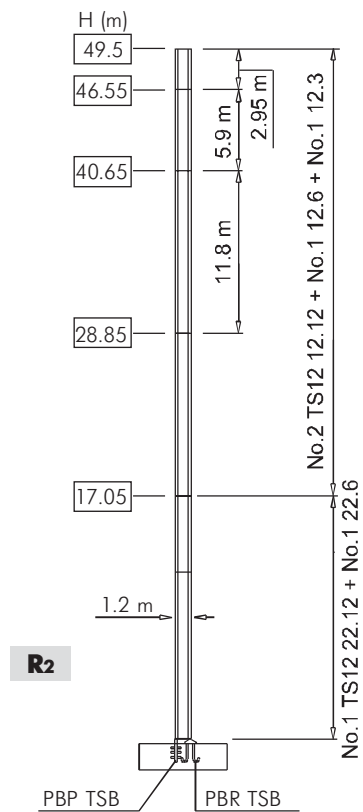
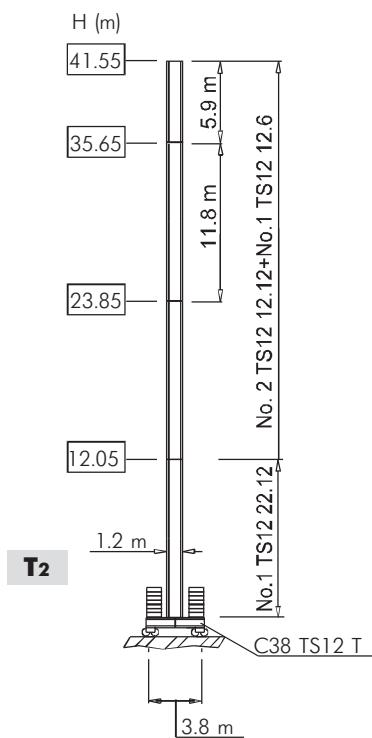
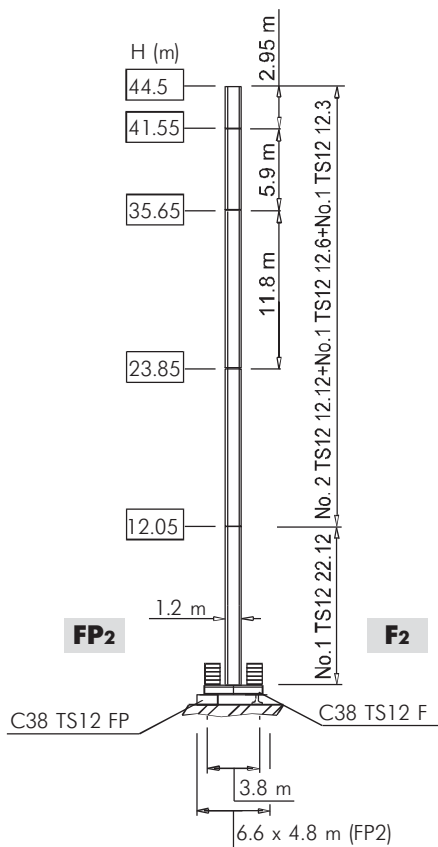
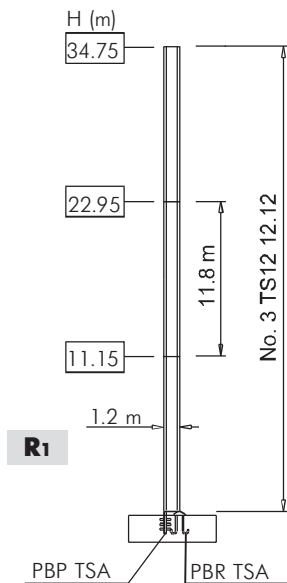
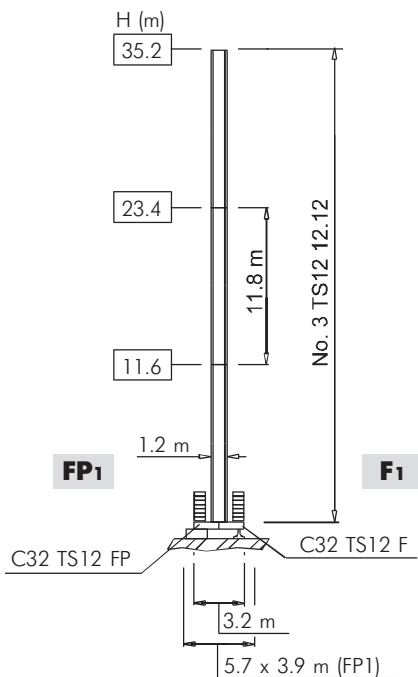

Доступны длины секций башни
TS: 11.8 м, 5.9 м и 2.95 м















Механизмы

			
 11 APC 25	27 кВА*	400 В – 50 Гц	2000/14/CE
15 AFC 25	38 кВА*	400 В – 50 Гц / 460 В – 60 Гц	

* Кран без оборудования для перевозки

			м/мин	т	кВт	
	11 APC 25		6	2.5	11	186 м
			20	2.5		
	40	1.25				
15 AFC 25 (VARIANT)			0 ⇔ 1.7	2.5	15	
			1.7 ⇔ 6	2.5		
			6 ⇔ 28	2.5		
			28 ⇔ 46	1.44		
			46 ⇔ 57	1.1		

		400 В – 50 Гц	
	DAD 2 2 D1	0 – 22 – 44 м/мин	2.2 – 1.5 кВт
	DVF 3 4 D5 (Variant)	0 ⇔ 6 ⇔ 30 ⇔ 60 м/мин	4 кВт
	SSR 1 1 50	0 ⇔ 0.87 об/мин	1 x 50 Нм
	TAD 1 RP 2 M3	0 – 24 м/мин	2 x 3 кВт
		1	

-  Подъем
-  Перемещение
-  Поворот
-  Передвижение
-  Указания по уровню шума
-  Проконсультируйтесь с нами
-  Потребляемая мощность
-  Источник питания

Gru Comedil s.r.l.

A Terex Company



Via S. Egidio 42/A, 33074 Fontanafredda (PN) - Italy
Tel. (+39) 0434 567 311 - Telefax (+39) 0434 998631

Internet e-mail: info@comedil.com
Internet home page: www.comedil.com

Divisione Automontanti

Via Alessandrina, 25 - 20095 Cusano Milanino (MI) - Italy
Tel. (+39) 02 613 16011 - Telefax (+39) 02 613 16034

Internet e-mail: info.CBR@comedil.com